

ecosa

TOKYO SOFA BED

Build your Sofa Bed in 5 easy steps

What's in the box?

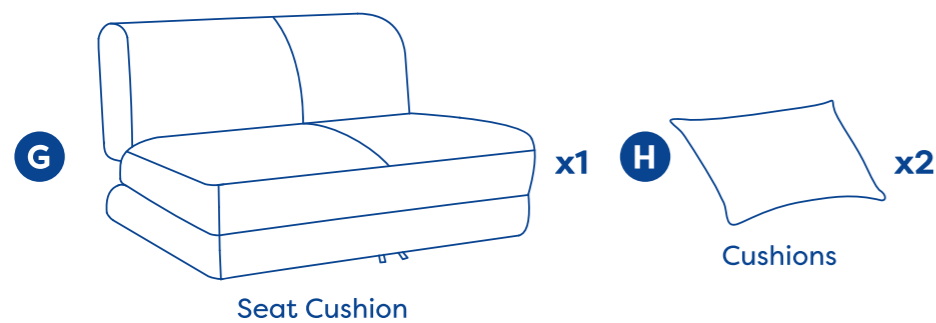
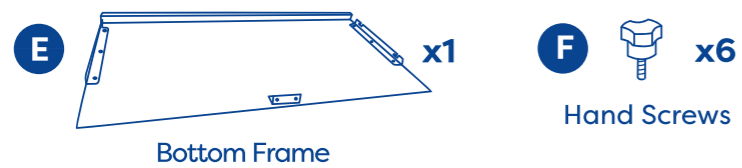
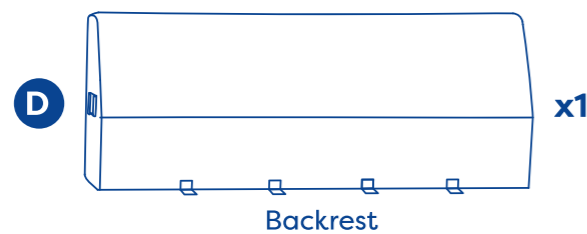

1

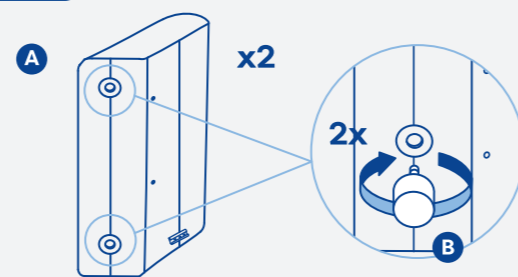

Install the arm legs (B) in each sofa arm (A). Wind in a clockwise direction to secure.

2

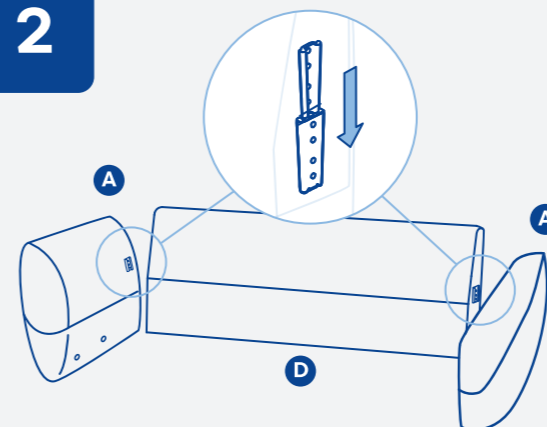

Place the arms (A) upright with the legs on the ground. To attach, slot the arm pieces into the attachments found on either side of the backrest (D).

3

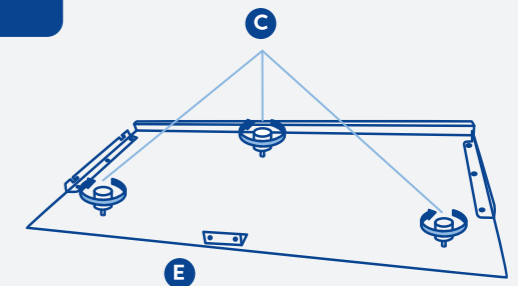

Screw the frame legs (C) into the bottom of the frame (E).

4

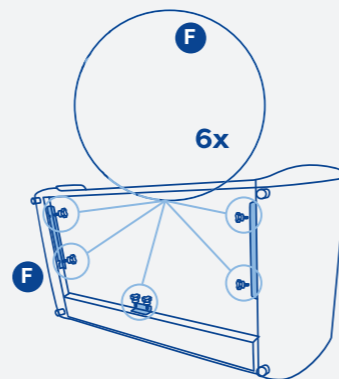

Tilt the sofa so the backrest is on the floor. Half screw in 4 hand screws (F) - 2 on the inside of each arm. Slide the bottom frame (E) to attach to these screws and secure with 2 more screws (F) in the centre of the frame. Tighten the screws on the arms to secure.

5

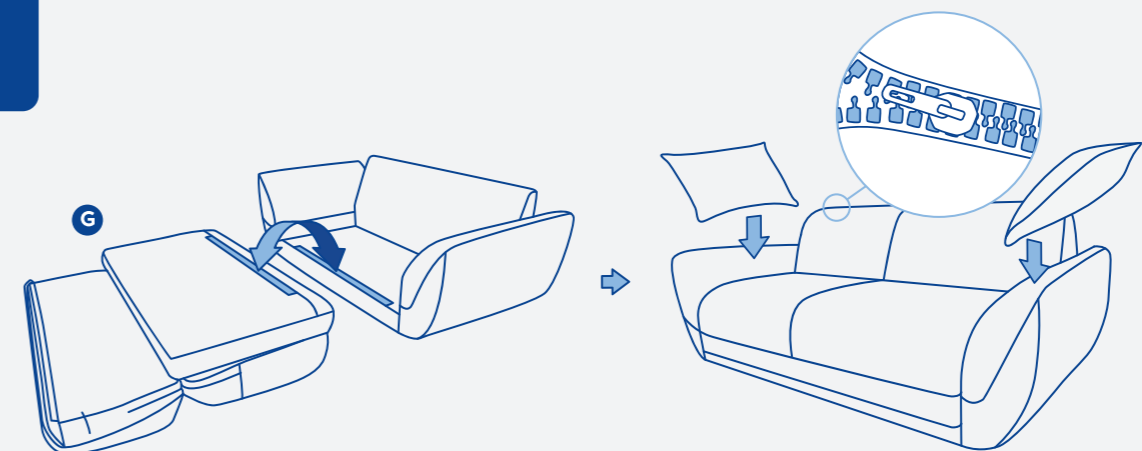

Place the sofa upright and add the seat cushion (G), making sure the velcro strips are connected. Fold the seat cushion back and attach the cushion to the backrest using the zip. Add side cushions (H).