

ecosa

SYDNEY SOFA BED

Build your Sofa Bed in 5 easy steps

What's in the box?

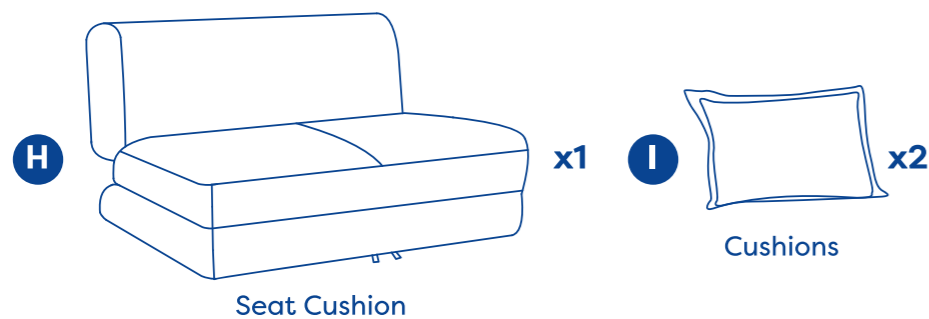
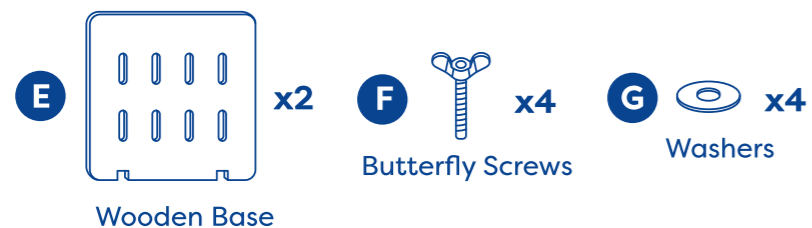
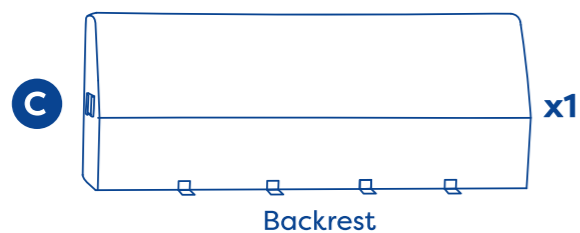
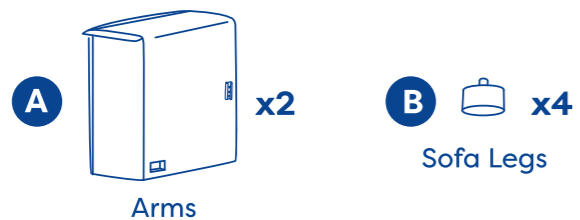

1

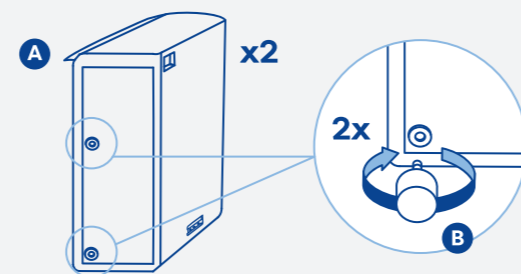

Lie each sofa arm (A) on its side and install the sofa legs (B). Wind in a clockwise direction to secure.

2

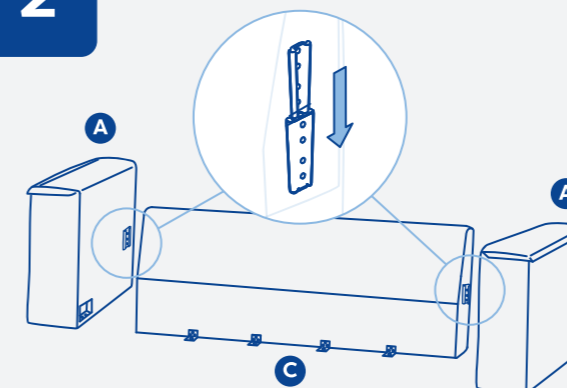

Place the arms (A) upright with the legs on the ground. To attach, slot the arm pieces into the attachments found on either side of the backrest (C).

3

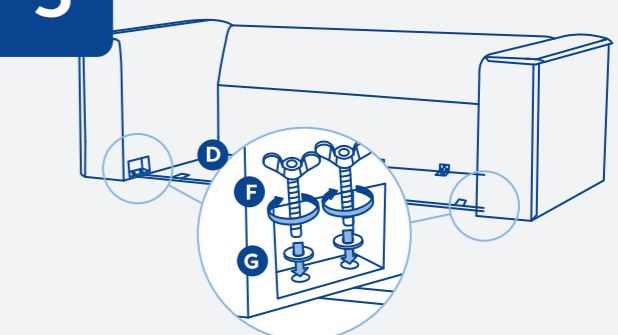

To attach the front rail (D), place it underneath the front edge of both arms and align with the screw holes found in the nook inside the arm. Secure tightly with 2 butterfly screws on each side of the sofa. (F, G)

4

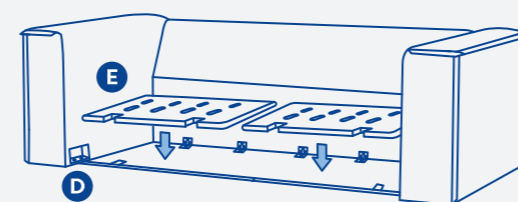

Insert the wooden base (E) as per the figure.

5

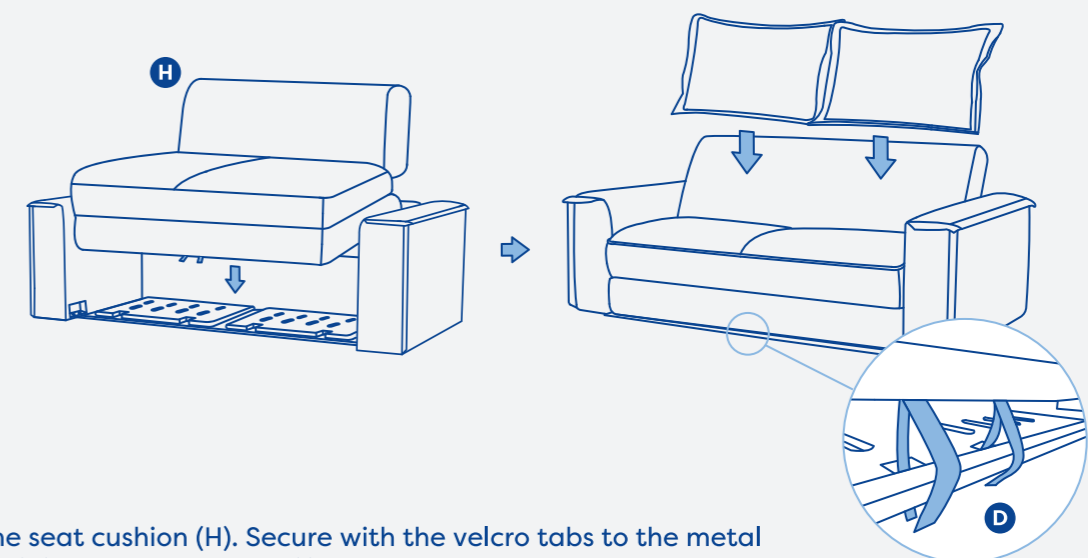

Insert the seat cushion (H). Secure with the velcro tabs to the metal front rail (D). Add the cushions (I), then put your feet up - you're done!